

Mât - Réactions / Mast - Reaktionskräfte / Mast - Reactions / Mástil - Reacciones / Torre - Reazioni
Tramo - Reacções / Реакция опор мачты

2,45 m - P 800B - C25							
ΔΔΔΔ (m)	30	40	45	50	55	60	
↕ (m)	65,6	62,3	57,3	57,3	52,3	52,3	
3,33 m	1	0	0	0	0	0	
	5 m	12	12	11	11	10	10
F2 (t)	● 219	214	224	218	217	213	
	■ 392	390	370	375	369	374	
F3 (t)	● 134	128	143	143	146	140	
	■ 320	316	298	300	299	300	
↕ (m) D25	57,3	54	49	49	44	44	

2,45 m - P 854A - C25							
ΔΔΔΔ (m)	30	40	45	50	55	60	
↕ (m)	77,3	74	70,6	70,6	65,6	65,6	
3,33 m	0	2	1	1	1	1	
	5 m	15	13	13	13	12	12
F2 (t)	● 253	251	265	255	255	250	
	■ 544	552	547	551	543	547	
F3 (t)	● 160	155	172	171	174	167	
	■ 463	469	463	467	462	464	
↕ (m) D25	67,3	62,3	59	59	54	54	

2,45 m - JM 850 - C25							
ΔΔΔΔ (m)	30	40	45	50	55	60	
↕ (m)	81,4	78,1	73,1	73,1	69,7	69,7	
3,33 m	0	2	2	2	1	1	
	5 m	14	12	11	11	11	11
F1 (t)	● 161	161	161	156	155	156	
	■ 237	240	229	231	236	238	
↕ (m) D25	68,1	64,7	58,1	58,1	56,4	56,4	

2,45 m - ZX 6830 - C25							
ΔΔΔΔ (m)	30	40	45	50	55	60	
↕ (m)	49,9	46,6	43,2	44,9	39,9	39,9	
3,33 m	2	1	0	2	2	2	
	5 m	8	8	8	7	6	6
F1 (t)	● 129	128	134	137	136	135	
	■ 140	138	137	153	152	155	
↕ (m) D25	41,6	38,2	36,6	36,6	31,6	31,6	

2,45 m - ZY 800 - C25							
ΔΔΔΔ (m)	30	40	45	50	55	60	
↕ (m)	63,7	58,7	55,3	55,3	50,3	50,3	
3,33 m	0	0	2	2	2	2	
	5 m	12	11	9	9	8	8
F1 (t)	● 142	134	136	134	131	129	
	■ 185	175	174	179	174	175	
↕ (m) D25	53,7	50,3	47	47	42	42	

2,45 m - ZY 854 - C25							
ΔΔΔΔ (m)	30	40	45	50	55	60	
↕ (m)	68,9	65,6	62,3	62,3	57,3	57,3	
3,33 m	0	2	1	1	1	1	
	5 m	13	11	11	11	10	10
F1 (t)	● 165	166	163	161	155	155	
	■ 226	230	218	232	217	226	
↕ (m) D25	57,3	53,9	50,6	50,6	45,6	45,6	

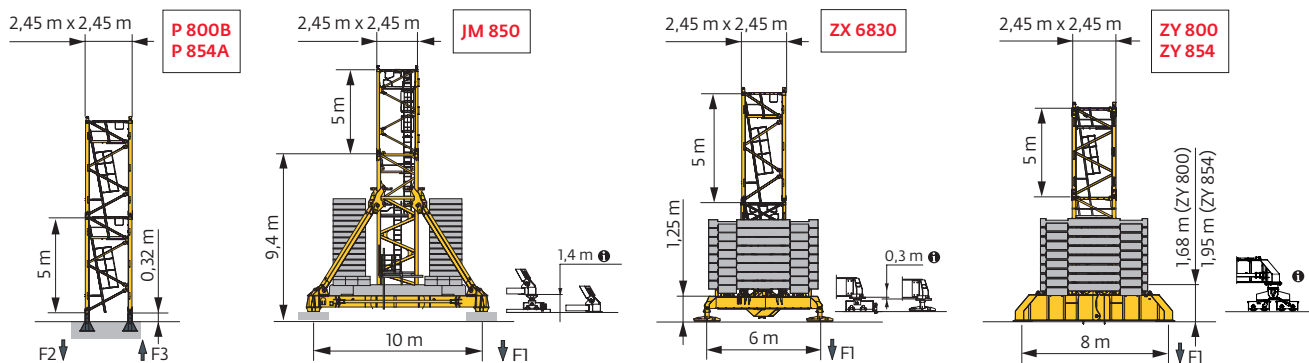

i Accès motorisés : compositions de mâture, de lest de base et réactions adaptées. / Motorisierter Zugang vom : Mastzusammensetzung, Grundballast und Reaktionskräfte sind angepasst. / Motorized accesses: adapted mast composition, base ballast and reactions. / Accesso a cabina con elevatore: Adattamento di composizione di mástil, lastre de base y reacciones. / Accessi motorizzati: composizioni elementi torre, zavorre di base e reazioni aggiornate. / Acessos motorizados: composições de coluna, lastro da base e reacções adaptadas. / Лифты : адаптированная композиция мачты, базовый балласт и нагрузки.

Ancrages / Verankerungen / Anchorages / Anclajes / Ancoraggi
 Ancoragem / Анкера

P 800B - C25

30 m

> 222,3 m

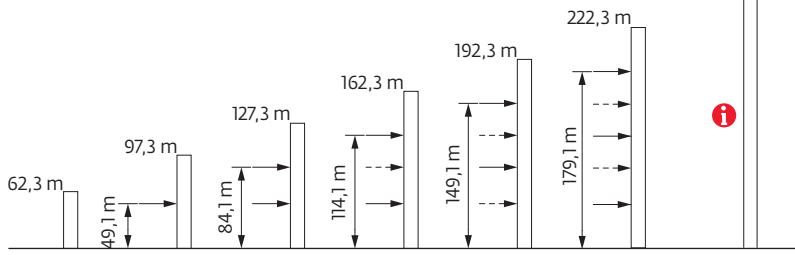

P 854A - C25

30 m

> 207,3 m

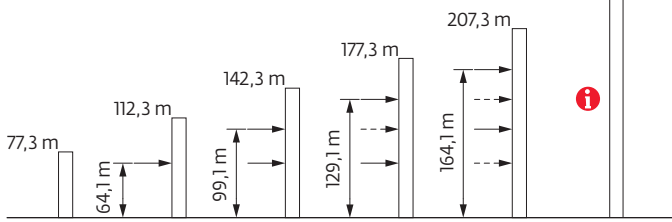

Lest de base / Grundballast / Base ballast / Lastre de base / Zavorra di base
 Lastro da base / Базовый Балласт

⚖️ (t) / 📏 2,45 m - JM 850 - 🚛 - C25

📏 (m)	30	40	45	50	55	60
81,4	216					
78,1	180	216				
73,1	144	168	216	216		
69,7	120	144	180	180	216	216
64,7	84	108	144	144	180	168
59,7	48	72	108	108	132	132
54,7	48	48	72	72	108	96
49,7	48	48	48	48	72	72
44,7	48	48	48	48	48	48
39,7	48	48	48	48	48	48
34,7	48	48	48	48	48	48
29,7	48	48	48	48	48	48
24,7	48	48	48	48	48	48
19,7	48	48	48	48	48	48

⚖️ (t) / 📏 2,45 m - ZX 6830 - 🚛 - C25

📏 (m)	30	40	45	50	55	60
49,9	131					
46,6	111	131				
44,9	101	121		161		
43,2	101	101	141	141		
39,9	101	91	111	101	161	161
34,9	101	91	111	91	111	111
29,9	101	91	111	81	91	81
24,9	101	91	111	81	81	71
19,9	101	91	111	81	81	61

⚖️ (t) / 📏 2,45 m - ZY 800 - 🚛 - C25

📏 (m)	30	40	45	50	55	60
63,7	156					
58,7	108	132				
55,3	84	108	144	144		
50,3	60	72	108	108	156	144
45,3	36	48	72	72	108	108
40,3	36	36	48	36	72	72
35,3	36	36	48	36	48	36
30,3	36	36	48	36	36	24
25,3	36	36	48	36	24	12
20,3	36	36	48	36	24	12

⚖️ (t) / 📏 2,45 m - ZY 854 - 🚛 - C25

📏 (m)	30	40	45	50	55	60
68,9	216					
65,6	192	216				
62,3	156	192	216	216		
57,3	108	132	168	180	216	216
52,3	72	96	120	120	168	180
47,3	48	60	84	84	132	120
42,3	36	36	48	60	96	96
37,3	36	36	36	24	60	60
32,3	36	36	36	24	36	24
27,3	36	36	36	24	24	24
22,3	36	36	36	24	24	12

Courbes de charges / Lastkurven / Load curves / Curvas de cargas / Curve di carico
 Curvas de carga / Кривые нагрузок

📏 (m)	17	20	22	25	27	30	32	35	37	40	42	45	47	50	52	55	57	60	m	
📏	📏 12 t																			
60	5,9 → 26,6	12	12	12	12	11,8	10,6	9,9	9	8,5	7,8	7,4	6,9	6,5	6,1	5,9	5,5	5,3	5	t
55	5,6 → 29,4	12	12	12	12	12	11,7	11	10,1	9,5	8,8	8,4	7,8	7,5	7	6,8	6,4	t		
50	5,2 → 36,1	12	12	12	12	12	12	12	12	11,7	10,8	10,2	9,5	9,1	8,5	t				
45	4,8 → 37,5	12	12	12	12	12	12	12	12	12	11,3	10,7	10	t						
40	4,4 → 37,8	12	12	12	12	12	12	12	12	12	11,3	t								
30	3,7 → 30	12	12	12	12	12	12	t												

📏 (m)	17	20	22	25	27	30	32	35	37	40	42	45	47	50	52	55	m	
📏	📏 24 t																	
55	5,6 → 21,3	15	15	14,5	12,8	11,8	10,6	10	9,1	8,6	8	7,6	7,1	6,8	6,4	6,1	5,8	t
50	5,2 → 23,6	18	18	18	17	15,6	13,9	13	11,8	11,1	10,2	9,6	8,9	8,5	7,9	t		
45	4,8 → 23,5	18	18	18	16,9	15,7	14,1	13,2	12,1	11,4	10,6	10,1	9,4	t				
40	4,4 → 18,8	24	22,5	20,4	17,8	16,4	14,6	13,7	12,4	11,7	10,7	t						
30	3,7 → 20	24	24	21,7	19	17,5	15,6	t										

Poids de flèche & lest de contre-flèche / Auslegergewicht & Gegenauslegerballast / Jib weight & counter-jib ballast / Peso de flecha y lastre de contra-flecha / Peso del braccio & zavorra di contro-braccio / Peso da lança & lastro da contra-lança
 Вес стрелы и балласт контр-стрелы

Jib length (m)	Jib weight (kg) (+/- 5%)		Counter-jib ballast (kg)	Total weight (kg)
	Symbol 1	Symbol 2		
60 m	12260	-	9	39600
55 m	12070	12620	9	39600
50 m	11150	11700	9	39600
45 m	10785	11335	9	39600
40 m	9840	10390	8	35200
30 m	8435	8985	7	30800

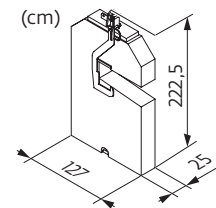

4400 kg

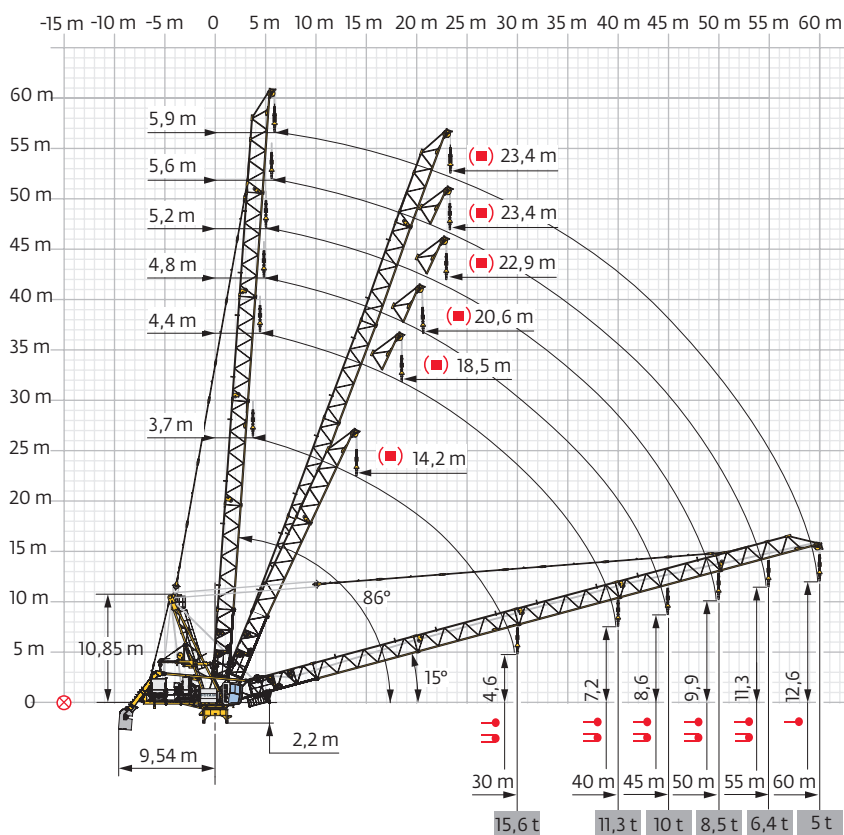

Flèche relevée / Ausleger in Steilstellung / Luffing jib / Flecha izada / Braccio impennato
 Lança inclinada / Маховая стрела







Encombrenment et poids / Abmessungen und Gewicht / Dimensions and weight / Dimensiones y peso / Ingombro e peso
dimensões e pesos / габаритные размеры и вес

Partie tournante / Drehender Kranteil / Slewing crane part / Parte giratoria
Parte rotante / Parte rotativa / Поворотная часть :  60 m -  150 HPL™

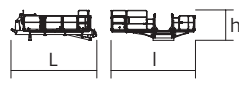
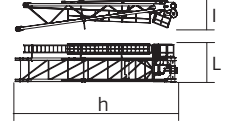
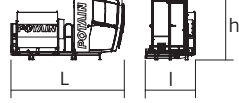
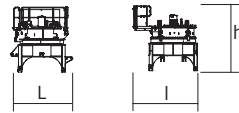
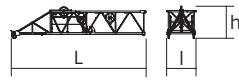
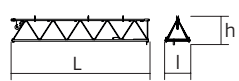
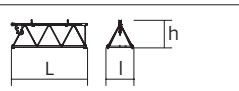
 x 11

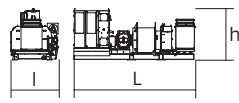
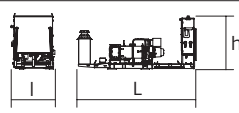
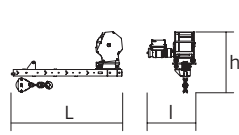
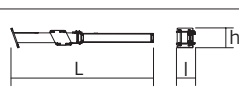
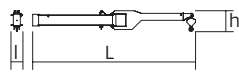
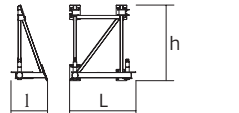
 x 10

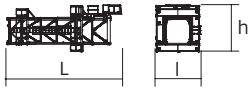
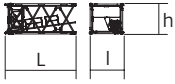
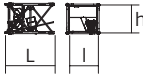
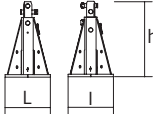
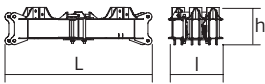
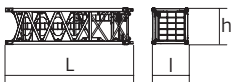
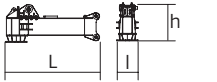
Partie tournante / Drehender Kranteil / Slewing crane part Parte giratoria / Parte rotante / Parte rotativa / Поворотная часть	L (m)	l (m)	h (m)	kg (+/- 5%)		
Contre-flèche (+ rambarde + plate-forme) Gegenausleger (+ Geländer + Plattform) Counter-jib (+ Grab rail + Platform) Contra-flecha (+ Guardacuerpos + Plataforma) Controbraccio (+ Parapetto + Piattaforma) / Contra-lança (+ Barreira + Plataforma) / Контр-стрела (+ Перила + Платформа)		6,43	6,35	2,1	4205	
Poinçon / Auslegerhaltebock Strut / Puntal Puntone / Extrator стойка		2,55	2,09	11,84	5550	
Cabine / Kabine Cab / Cabina Cabina / Cabina Кабина		Ultra View	4,42	1,99	2,49	1640
Pivot / Krankopf Towerhead / Pivote Portaralla / Pivot Секция поворотной части		□ 2,45 m	3,08	3,27	3,38	10470
Élément de flèche / Auslegerelement Jib section / Elemento de flecha Elemento di braccio / Elemento de lança Секция стрелы		①	9,64	2,11	2,26	2720
Élément de flèche / Auslegerelement Jib section / Elemento de flecha Elemento di braccio / Elemento de lança Секция стрелы		② ③ ④ ⑤ ⑥	10,54 10,53 10,53 10,53 10,46	1,9 1,9 1,9 1,9 1,9	2,25 2,01 2,01 2,01 2,42	1315 1430 1215 1060 1990
Élément de flèche / Auslegerelement Jib section / Elemento de flecha Elemento di braccio / Elemento de lança Секция стрелы		④A	5,37	1,9	2,01	715
Moufle / Hubflasche Pulley block / Aparejo Bozzello / Cadernal Полиспаст		GH	0,88 1,56	0,55 0,45	2,55 2,51	1180 690
Treuil de levage (+ câble) / Hubwerk (+ Seil) Hoisting winch (+ rope) / Mecanismo de elevación (+ cabo) Argano di sollevamento (+ fune) Guincho de elevação (+ cabo) Подъемная лебедка (+ канатом)		150 HPL™ 270 LVF	4,92 5,61	2,28 2,17	1,93 2,37	10265 14090
Treuil de relevage (+ câble) / Auslegerverstellwerk (+ Seil) Luffing winch (+ rope) / Mecanismo de izado (+ cabo) Argano di Impennaggio braccio (+ fune) Mecanismo de Inclinação da Lança (+ cabo) лебедка подъема стрелы (+ канатом)		150 VVF	4,88	1,72	2,17	4935
Bras de potence arrière gauche (+ treuil auxiliaire + moufle) Hinterer linker Hilfsgalgenarm + Hilfstriebwerk + Hubflasche Rear left derrick arm (+ auxiliary winch + pulley block)/Brazo de plumín trasero izquierdo + cabrestante auxiliar + aparejo Braccio della mensola posteriore sinistro + argano ausiliario + bozzello/Braço de potência traseiro esquerdo + guincho auxiliar + cadernal/Траверса кронштейна (задняя левая) + дополнительный подъемник + полиспаст			2,38	1,05	1,3	615
Bras de potence avant gauche/Vorderer linker Hilfsgalgenarm Front left derrick arm/Brazo de plumín delantero izquierdo/ Braccio della mensola anteriore sinistro/Braço de potência dianteiro esquerdo/Траверса кронштейна (передняя левая)			3,49	0,44	0,48	190
Bras articulé de potence/Gelenkiger Hilfsgalgenarm/Articula- ted derrick arm/Brazo de plumín articulado/Braccio articolato della mensola/Braço articulado de potência/ Подвижная траверса кронштейна			4,21	0,3	0,54	315
Support de potence / Hilfsgalgenträger / Derrick support Soporte de plumín / Supporto della mensola / Suporte de potência / Опора кронштейна			1,99	1,09	2,27	670

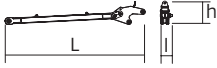
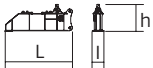
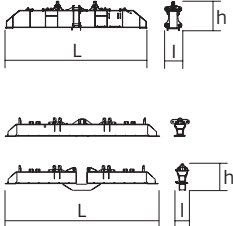
Руло́не / Kranturm / Crane tower Mástil / Torre / Torre Башня крана		L (m)	l (m)	h (m)	kg (+/- 5%)	
T 851		2,45 m	11,18	4,84	5,8	15750
K 85/KR 84B2 KM 850.10B KM 850.14B K 85/KR 84A2 KMT 849A KRMT 849A K 849A KR 849A KMT 850.10A KMT 850.14A		2,45 m	10,24 10,32 10,32 5,24 5,23 5,23 5,23 5,23 5,32 5,32	2,54 2,54 2,54 2,54 2,55 2,55 2,53 2,53 2,54 2,54	2,5 2,51 2,51 2,5 2,53 2,53 2,5 2,5 2,51 2,51	9635 10070 11190 5550 3150 4090 3400 4290 5450 5990
KRMT 849C		2,45 m	3,57	2,55	2,53	3205
Pieds de scellement / VerankerungsfüÙe Fixing angles / Pie de empotramiento Montante da anegare / Angulos fixadores анкера		P 800B P 854A	0,75 0,9	0,75 0,9	1,28 1,5	465 940
Croix centrale (position transport) / Zentralkreuz (Transport- position) / Central cross (transport position) / Braço central (posición transporte) / Croce centrale (posizione di trasporto) Braço central chassis (posição transporte) / крестообразное основание (транспортное положение)		JM 850	5,2	1,7	1,5	6700
Mât-châssis / Grundmasteinheit Basic mast unit / Tramo-chasis Elemento base / Tramo-chassis Мачта для крепления к шасси		JM 850	8,75	2,5	2,5	14600
Bras de châssis / Unterwagenträger / Chassis girder / Braço de base en cruz / Traverso del carro / Braço de chassis / опорная балка шасси		JM 850	5,2	0,9	1,55	3200
Tirant de châssis / Unterwagenstreben / Chassis ties / Tirante de base en cruz / Tiranti del carro / Tirante de chassis / тяга крепления шасси		JM 850	7,2	0,25	0,35	250
Haubans / Mastabstützungen Struts / Tornapuntas Puntoni / Escoras Растяжка		JM 850	8,2	0,75	1,3	2300
1/2 Bras de croix / 1/2 Fundamentkreuzträger 1/2 Cross girder / 1/2 Braço en cruz 1/2 Braccio croce / 1/2 Braço da cruz 1/2 Поперечная балка		ZY 800 ZY 854	5,68 5,66	0,98 0,98	1,92 2,27	4720 5940
Bras de croix / Fundamentkreuzträger Cross girder / Braço en cruz Braccio croce / Braço da cruz Поперечная балка		ZY 800 ZY 854 ZX 6830	11,96 11,9 9,1 9,1	1,39 1,42 1,12 0,76	1,92 2,27 1,1 1,48	10075 13350 5265 5445

Mécanismes / Triebwerke / Mechanisms / Mecanismos / Meccanismi
 Mecanismos / Механизмы

400 V - 50 Hz													ch - PS hp	kW	
	150 HPL™ 120	m/min	47	59,5	82	137	210	23,5	30	41,5	70	105	150	110	552 m
		t	12	9	6	3	1,5	24	18	12	6	3,2			
	270 LVF 120 Optima	m/min	84	108	148	205	254	42	54	80	103	127	270	200	826 m
		t	12	9	6	3,7	1,7	24	18	12	8,9	4,8			
	150 VVF 56		1 min 15 s									150	110		
	RVF 162 Optima +	tr/min U/min rpm	0 → 0,9									2 x 7,5	2 x 5,5		

400 V (+10% -10%) 50 Hz	150 HPL™ + 150 VVF : 254 → 134 kVA 270 LVF + 150 VVF : 350 → 182 kVA

	FR	DE	EN	ES	IT	PT	RU
	Profil de vent suivant EN 14439 C25-D25	Windbedingungen gemäss EN 14439 C25-D25	Wind conditions according to EN 14439 C25-D25	Conformidad de los condiciones de viento EN 14439 C25-D25	Condizioni del vento secondo EN 14439 C25-D25	Perfil de vento conforme EN 14439 C25-D25	Ветровой режим в соответствии с EN 14439 C25-D25
	Équipements standards	Standardausrüstungen	Standard equipment	Equipamiento de serie	Equipaggiamento standard	Equipamento de série	Стандартное оборудование
	Équipements optionnels	Sonderausrüstungen	Options	Equipamiento opcional	Equipaggiamento in opzione	Equipamento opcional	Дополнительное оборудование (опция)
	Réactions en service	Reaktionskräfte in Betrieb	Reactions in service	Reacciones en servicio	Reazioni in servizio	Reações em serviço	Реакция при работе
	Réactions hors service	Reaktionskräfte außer Betrieb	Reactions out of service	Reacciones fuera de servicio	Reazioni fuori servizio	Reacções fora de serviço	Реакция в покое
	Poids de flèche	Auslegergewicht	Jib weight	Peso de flecha	Peso del braccio	Peso da lança	вес стрелы
	Poids total du lest	Ballast-Gesamtwicht	Total ballast weight	Peso total del lastre	Peso totale della zavorra	Peso total do lastro	Общий вес балласта
	Axe articulation flèche	Auslegergelenk-achse	Jib articulation axis	Eje de articulación de la flecha	Perno di articolazione del braccio	Eixo de articulação da lança	Ось шарнира стрелы
	Position girouette	Windfreistellung	Weathervaning position	Posición veleta	Libera rotazione	Posição em cata-vento	Флюгер
	Camion 13,4 m	Lkw 13,4 m	Lorry 13,4 m	Camión 13,4 m	Camion 13,4 m	Camião 13,4 m	Ррузовой автомобиль 13,4 м
	Conteneur High Cube 40', et/ou Flat Rack 20'	Container High Cube 40', and/oder Flat Rack 20'	Container High Cube 40', and/or Flat Rack 20'	Contenedor High Cube 40', y/o Flat Rack 20'	Container High Cube 40', e/o Flat Rack 20'	Contentor High Cube 40', e/ou Flat Rack 20'	40-футовый контейнер повышенной вместимости High Cube, и/или 20-футовая открытая платформа Flat Rack
	Cadre d'ancrage serré	Fester Verankerungsrahmen	Tightened anchorage frame	Marco de anclaje de apriete	Quadro di ancoraggio stretto	Quadro de amarração apertado	Прикрепленная анкерная рама
	Cadre d'ancrage desserré	Looser Verankerungsrahmen	Loosened anchorage frame	Marco de anclaje de desapriete	Quadro di ancoraggio allentato	Quadro de amarração solto	Отсоединенная анкерная рама
	Levage	Heben	Hoisting	Elevación	Sollevamento	Elevação	Подъем
	Relevage	AL-Verstellen	Luffing	Izado	Brandeggio	Levantamento	Маховый подъем
	Orientation	Schwenken	Slewing	Orientación	Rotazione	Rotação	Поворот
	Translation	Kranfahren	Travelling	Traslación	Traslazione	Tranlação	Перемещение крана
	Puissance requise	Erforderliche Leistung	Required power	Potencia Necesaria	Potenza richiesta	Potência Necessária	Потребляемая мощность
	Fonction Power Control : vitesses treuils adaptées à la puissance disponible	Funktion Power Control: Geschwindigkeiten der Triebwerke werden an die verfügbare Leistung angepasst	Power Control Function: winch speeds adapted to the available power	Función Power Control: marchas de los cabrestantes adaptadas a la potencia disponible	Funzione Power Control: velocità degli argani adattate alla potenza disponibile	Função Power Control: velocidades de guincho adaptadas à potência disponível	Функция контроля мощности Power Control: регулировка скорости лебедок в зависимости от доступной мощности
	Nous consulter	Auf Anfrage	Consult us	Consultarnos	Consultateci	Consultar-nos	Проконсультируйтесь у нас
	Document commercial non contractuel. Pour toute information technique se référer à la notice correspondante.	Unverbindliches Vertriebsdokument. Für technische Informationen, siehe die entsprechenden Anweisungen.	This commercial document is not legally binding. For any technical information, please refer to the corresponding instructions.	Documento comercial no contractual. Para cualquier información técnica, ver la noticia correspondiente.	Documento commerciale non vincolante, per tutte le informazioni tecniche fare riferimento al catalogo istruzioni.	Documento comercial não contratual. Para qualquer informação técnica complementar consultar as respectivas instruções.	Этот коммерческий документ не является юридически обязательным. Для получения технической информации, см. соответствующие инструкции.

